

IS2021



**Summer med flash for montering
på vegg**

Generelt:

Summeren driftes fra en 24 V DC klokkekurs med fast spenning ved alarm. Det er dobbelt sett med + og - terminaler for videreføring av klokkekurskabelen til neste sirene. Siste sirene termineres med en endemotstand dersom de er tilkoblet en NAC utgang.

Tonen som blir spilt når summeren aktiveres kan man velge via DIP switcher.

Tekniske spesifikasjoner		
Driftsspenning	Område	Fra 20 til 30 V DC
	Normal	24 V DC
Strømforbruk	I standby	500 µA
	Maksimalt	I alarm (se tabell «forbruk»)
Driftsmiljø	Temperatur	Fra -10 til +55 °C
	Relativ luftfuktighet	≤ 75% uten kondensering
Miljø type	A (innendørs bruk)	
IP grad	IP65	
Installasjonsmetode	Veggmontering	
Dimensjoner (HxBxD)	121 x 121 x 57mm	
Vekt	150 g	
RAL farge	9003 Hvit	
	9011 Sort	
Godkjenninger	EN54-3 og FG	
Artikkelnummer		

Skjema:

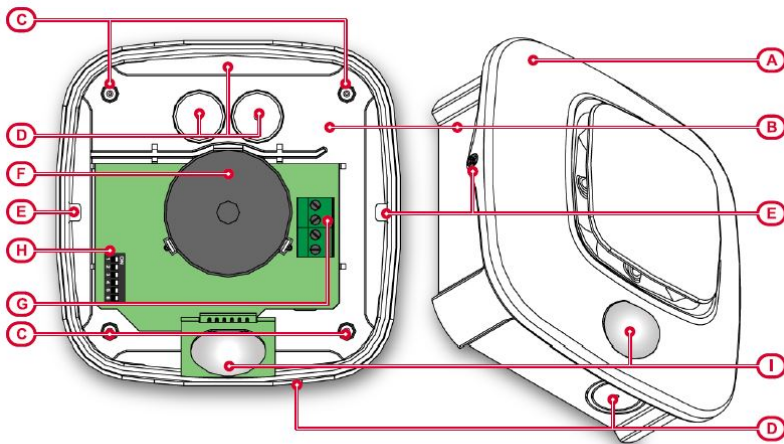

Beskrivelse av enheten			
A	Deksel	F	Summer
B	Bakboks	G	Terminal tilkoblinger
C	Ferdig uttak for montasjehull	H	Tilkobling for programmering
D	Kabel hull	I	LED
E	Skrue til deksel		

Tilkoblingsterminaler	
+	Positiv terminal – 2 stk
-	Negativ terminal – 2 stk
LED signaler	
Grønn LED	Programmering pågår
Gul LED	Programmeringsenheten er tilkoblet

DIP switches





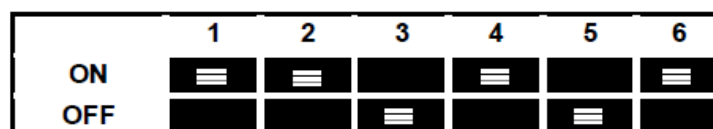





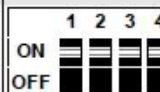









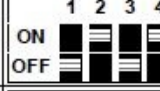

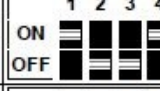

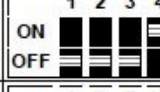

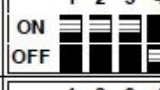

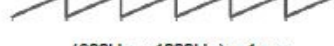
Switches	ON	OFF
1		
2	Valg av tone	
3	(se tabell)	
4		
5	Flasher styrke	
	Høy	Lav
6	Lyd styrke	
	Høy	Lav

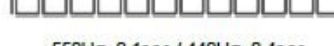
Sett DIP switch i følgende posisjoner

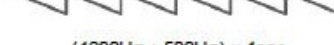

Med denne innstillingen, brukes Nortek's standard innstilling

Tone innstillinger:

N°	Name	Description	EN54-3 approved	DIP switch
0	Silence	No tone		
1	ISO 8201 2800Hz	 2800Hz, (0.5sec ON / 0.5sec OFF) x3 / 1sec OFF		
2	ISO 8201 1000Hz	 1000Hz, (0.5sec ON / 0.5sec OFF) x3 / 1sec OFF	✓	
3	1KHz/800Hz 2Hz	 (1000Hz + 800Hz) x 0.5sec		
4	NEN 2575:2000 (Dutch slow whoop)	 (500Hz ÷ 1200Hz) x 3.5sec / 0.5sec OFF	✓	
5	SIN 1000Hz	 1000Hz	✓	
6	SIN 2800Hz	 2800Hz		
7	Fast whoop (AS1670)	 (500Hz ÷ 1200Hz) x 0.5sec / 0.5sec OFF	✓	
8	1000Hz 1sON/1sOFF	 1000Hz, 1sec ON / 1sec OFF		
9	800Hz 0.2/1s	 800Hz, 0.2sec ON / 1sec OFF		
10	800-1KHz 1Hz	 (800Hz ÷ 1000Hz) x 1sec	✓	
11	AFNOR NF S 32 001	 550Hz, 0.1sec / 440Hz, 0.4sec		
12	AS 1670 Alert	 420Hz, 0.625sec ON / 0.625sec OFF	✓	
13	AS1670 Evacuation	 ((500Hz ÷ 1200Hz) x 0.5sec / 0.5sec OFF) x3 / 1.5sec OFF	✓	
14	DIN 33 404	 (1200Hz ÷ 500Hz) x 1sec	✓	

Forbruk:

N°	Name	Sound level (dB@ 1m)		Absorption, low volume (mA)			Absorption, high volume (mA)		
		min	max	tone	tone + low level flash	tone + high level flash	tone	tone + low level flash	tone + high level flash
0	Silence	0	0	0	0	0	0	0	0
1	ISO 8201 2800Hz	88	98	xx	xx	xx	xx	xx	xx
2	ISO 8201 1000Hz	77	87	2.6	14.6	20.6	2.9	14.9	20.9
3	1KHz/800Hz 2Hz	77	87	2.2	14.2	20.2	2.7	14.7	20.7
4	NEN 2575:2000 (Dutch slow whoop)	85	89	2.5	14.5	20.5	3	15	21
5	SIN 1000Hz	77	87	2.7	14.7	20.7	2.86	14.86	20.86
6	SIN 2800Hz	88	98	xx	xx	xx	xx	xx	xx
7	Fast whoop (AS1670)	81	88	2.5	14.5	20.5	2.7	14.7	20.7
8	1000Hz 1sON/1sOFF	77	87	1.4	13.4	19.4	2	14	20
9	800Hz 0.2/1s	77	87	1.7	13.7	19.7	2.2	14.2	20.2
10	800-1KHz 1Hz	77	87	2.5	14.5	20.5	2.7	14.7	20.7
11	AFNOR NF S 32 001	76	85	1.4	13.4	19.4	1.7	13.7	19.7
12	AS 1670 Alert	77	86	1.5	13.5	19.5	1.6	13.6	19.6
13	AS1670 Eva- cuation	81	88	2.5	14.5	20.5	3	15	21
14	DIN 33 404	83	89	2.5	14.5	20.5	3	15	21

Dekningsområdet flash

